

NOTE: DIMENSIONS LOCATED IN BOXES ARE COMMON
SETBACK DIMENSIONS FOR EACH FITTING

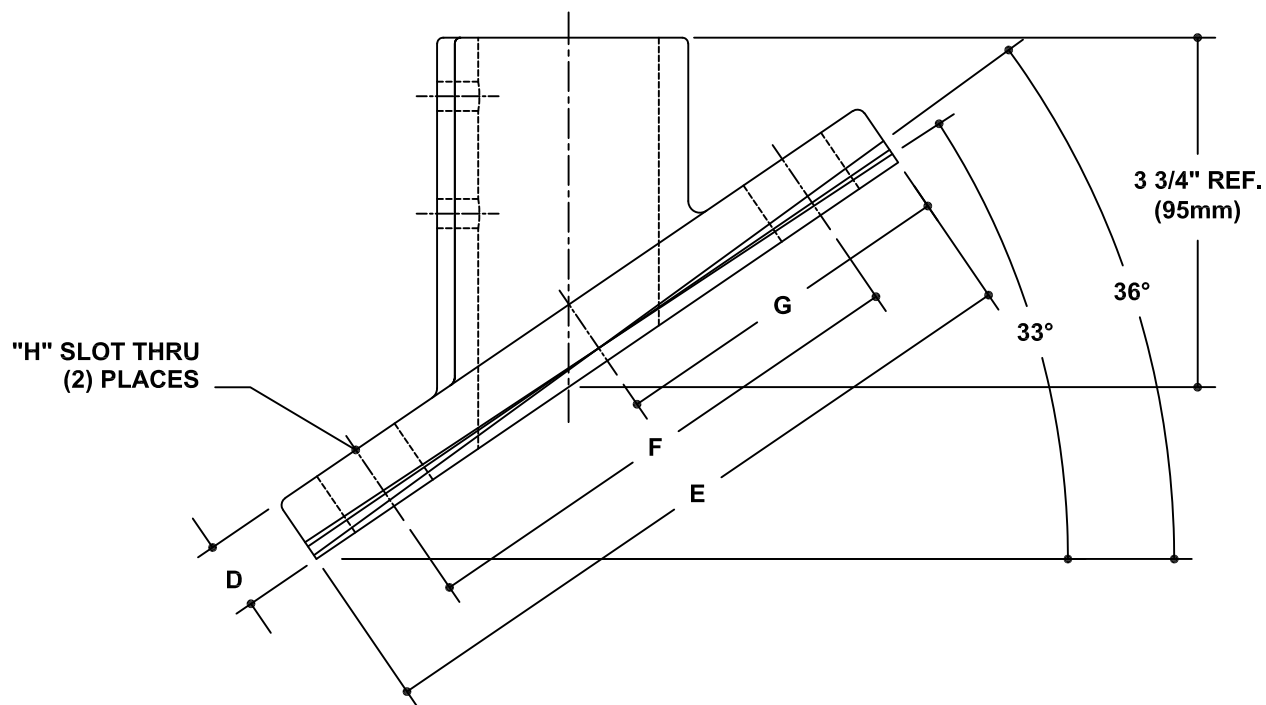
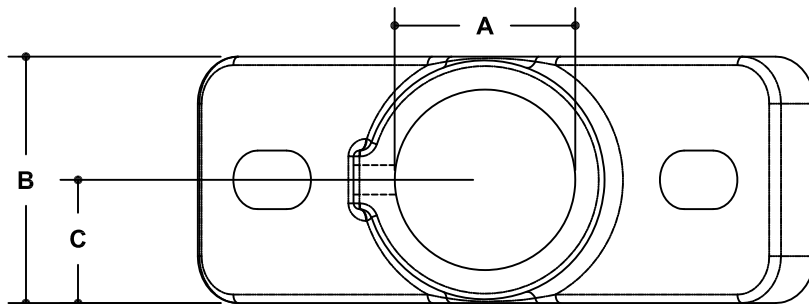

#46AF2 Angle Flange

SCALE: HALF

ENGLISH UNITS (Inches)

PIPE SIZE	A	B	C	D	E	F	G	H
1½"	1.93	2.63	1.31	0.75	7.50	5.50	3.75	.63x1

METRIC UNITS (mm)

PIPE SIZE	A	B	C	D	E	F	G	H
1½"	49	67	33	19	191	140	95	16x25